



8 Winn Avenue • Hudson, NH 03051 • USA

CCM-200 plus

Chlorophyll Content Meter



Table of contents

TABLE OF CONTENTS	INTRODUCTION	2
INTRODUCTION		3
WELCOME!		3
LIST OF EQUIPMENT		3
ABOUT THE INSTRUMENT		3
APPLICATIONS & FEATURES		4
<i>Applications</i>		4
<i>Features</i>		4
<i>How it Works</i>		5
PHYSICAL FEATURES		6
OPERATION OVERVIEW		6
SYSTEM SETTINGS		7
MEASUREMENT & OPERATION		7
MEASUREMENTS		8
<i>Setup</i>		8
CALIBRATION		9
TEST TYPES		10
<i>Single point measurement</i>		10
<i>Multi-Point averaging</i>		10
<i>Multi-Point averaging with std. deviation flyer removal</i>		10
ENTER COMMENTS FOR MEASUREMENTS		12
DATA MANAGEMENT		14
TRANSFER DATA BY USB		14
SENDING DATA BY RS232		14
<i>Communication Settings</i>		15
TECHNICAL SPECIFICATIONS		16
ERROR CODES		17
TECHNICAL SUPPORT		22
REFERENCES:		23

Introduction

The CCM-200 plus is easy to operate. Contained herein are a few simple guidelines to assist the user. Throughout this manual, you will be shown setup options and response messages. When an example of a program screen is shown within a box, this is how it will appear on the CCM-200 plus.

Welcome!

Congratulations on your purchase of the CCM-200 plus Chlorophyll Content Meter. Please check the carton for any visible external damage. If you notice any damage, notify the freight carrier immediately. Follow their procedures for reporting and filing a claim. The carton and all packaging should be retained for inspection by the carrier or their insurer.

List of Equipment

Report any missing items immediately. You should have received the following items:

- CCM-200 plus Chlorophyll Content Meter
- USB cable
- 9V Battery
- CD with manual

About the Instrument

The CCM-200 plus Chlorophyll Content Meter is a hand-held, battery-operated instrument designed for the rapid, non-destructive, determination of chlorophyll content in intact leaf samples. Chlorophyll content is a direct indication of plant health and condition. Obtaining chlorophyll content via non-destructive analysis gives researchers, agronomists and growers valuable diagnostic information. This data can then be applied to a multitude of crop production and research initiatives such as nutrient and irrigation management, pest control, environmental stress evaluation and crop breeding.

Measurements are instantaneous and can be done in the field under normal lighting and growing conditions. Ample on-board data logging and simple, easy to understand measurements further enhance the user's ability to gather and interpret crop health conditions. The USB cable included with the CCM-200 plus allows for data transfer to a PC. for additional analysis.

The CCM-200 plus is a remarkable alternative to destructive sampling techniques. It is far less time consuming and allows samples to be monitored multiple times over various stages of an entire growth cycle. The rapid test and data gathering capability is sure to provide a tremendous advantage to all types of research. This innovative pocket-sized instrument is destined to play an important role in improving crop yield and producing higher quality foods.

Applications & Features

The CCM-200 plus Chlorophyll Content Meter is a versatile tool for Crop, Plant and Agronomic Sciences. Listed below are a few examples of the many applications for which the CCM-200 plus can be used along with the user-friendly features that make the instrument indispensable to the field researcher.

Applications

- Optimization of Nitrogen Management
- Detecting & Assessing Crop/Plant Stress
- Nutrient Deficiency Analysis
- Plant/Crop Physiology
- Study Effects of Herbicides/Pesticides
- Monitor Response to Environmental Stress
- Leaf Senescence Studies
- Breeding and Production
- Teaching

Features

- Non-Destructive Measurement
- Lightweight, Hand-Held Design
- Optimized for Field Work
- Battery Operated
- Accurate Reliable, Easily Repeatable Measurements
- Internal Data Logging
- Stand Alone Operation- No PC is Required
- Simple to Use
- Rapid Test & Data Acquisition
- Single reading; averaging of multi-point readings, or averaging of 10 to 30 readings with standard deviation elimination function, used to throw out readings that are outside of a two sigma range.
- Includes a port for external GPS. The GPS can be purchased separately. The GPS allows the recording of measurement values with location information.
- Graphic display of Averaging measurements.

How it Works

Chlorophyll has several distinct optical absorbance characteristics that the CCM-200 plus exploits in order to determine relative chlorophyll concentration. Strong absorbance bands are present in the blue and red but not in the green or infrared bands.

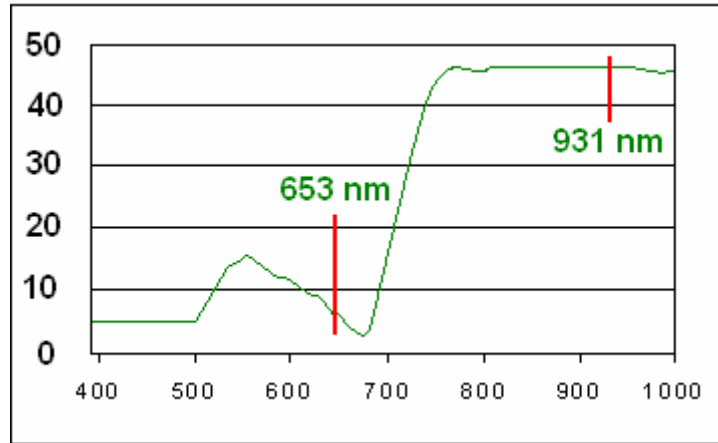

Figure 1 chlorophyll absorbance

$$\text{CCI} = \% \text{Transmittance at } 931\text{nm.} / \% \text{Transmittance at } 653\text{nm.}$$

The CCM-200 plus uses transmittance to estimate the chlorophyll content in leaf tissue. Two wavelengths are used for absorbance determinations. One wavelength falls within the chlorophyll absorbance range while the other serves to compensate for mechanical differences such as tissue thickness (see figure 2). The meter measures the transmittance of both wavelengths and calculates a CCI (chlorophyll content index) value that is proportional to the amount of chlorophyll in the sample.

Note: CCI value is a relative chlorophyll value. Absolute chlorophyll content per unit area is not computed. CCM-200 plus measurements however can be correlated to ground/solvent analysis.

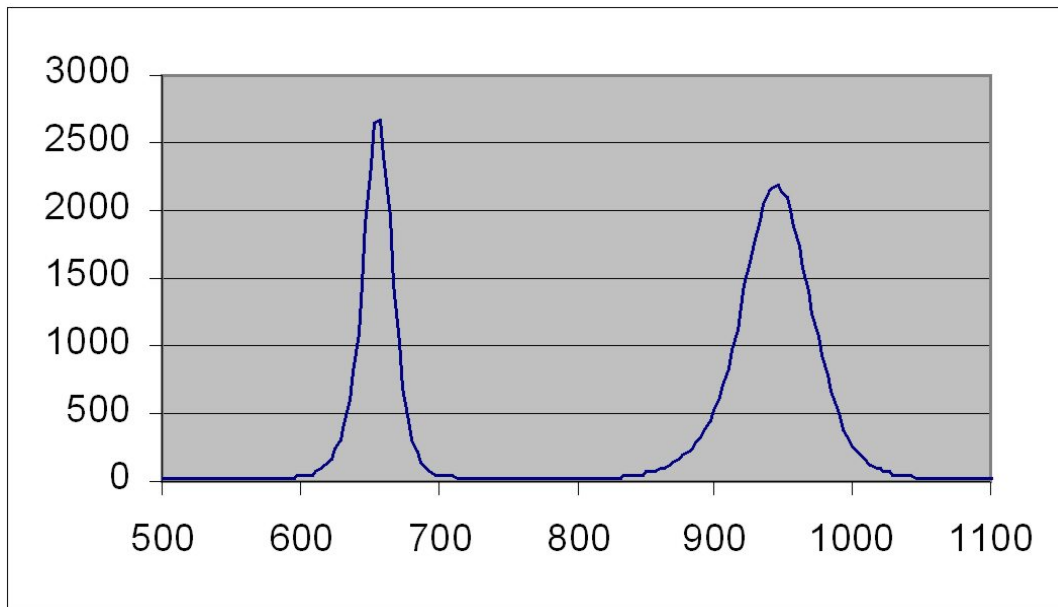

Figure 2. LED Spectrum

Physical Features



Operation Overview

The CCM-200 plus is a self-contained, handheld device powered by a 9V alkaline battery. The sample head is located at the top of the instrument. A liquid crystal display (LCD) is located near the center of the unit. The power switch is at the bottom of the front panel. Seven menu / control keys are used to access all program functions.

Program flow is organized into 3 menu groups. The MENU key will step through the selections. Press ENTER to accept the currently displayed value. Remaining keys are used within each mode as later described.

A USB port is located at the bottom right hand side of the case and allows the user to export data to a PC. A RS232 port is included on the bottom for use with GPS, and it can also be used for data transfer.

The three green tear shaped buttons are for selecting software defined choices and will be described as “buttons”. The blue arrow keys are used for scrolling and referred to as “arrow keys”.

Note: The unit has a 4 minute auto-off feature. When no key is pressed, or test run for 4 minutes the unit will shut off automatically in order to conserve battery power.

System settings

At the main test menu, choose System

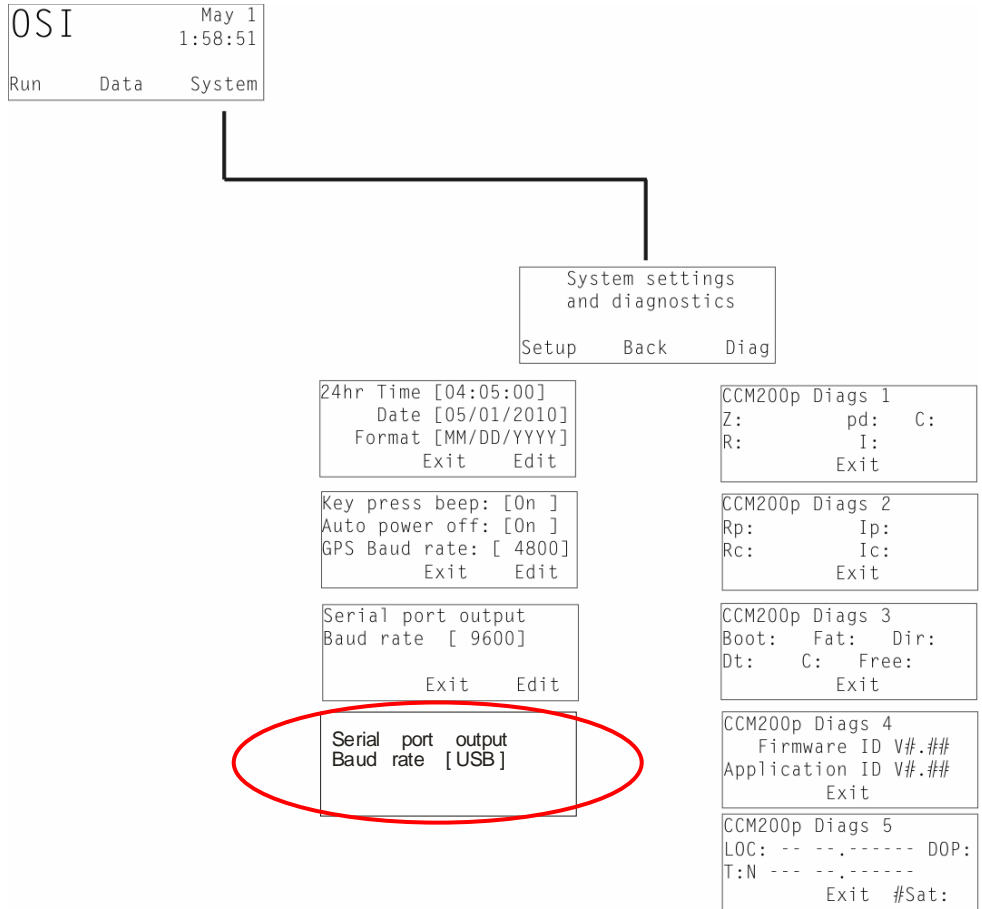

Measurement & Operation

Described on the following pages are the specifics on how to obtain measurements with the CCM-200 plus as well as the overall instrument operation protocols. Calibration, measurements, memory and data storage management and the five operating modes and each key function are outlined in detail.

Measurements

Turn on the instrument. After a few seconds, the main menu screen appears.

```

OSI                               May 1
                               1:58:51
Run   Data   System
    
```

Press the Run button.

```

Test Menu
Measure Back Setup
    
```

Before measuring, use setup to select the correct parameters and test type.

Setup

Use the arrow keys to scroll through the options.

When the option of interest is displayed, select the edit button.

A cursor will appear. Use the arrow keys to highlight your selection.

Press the exit button when finished.

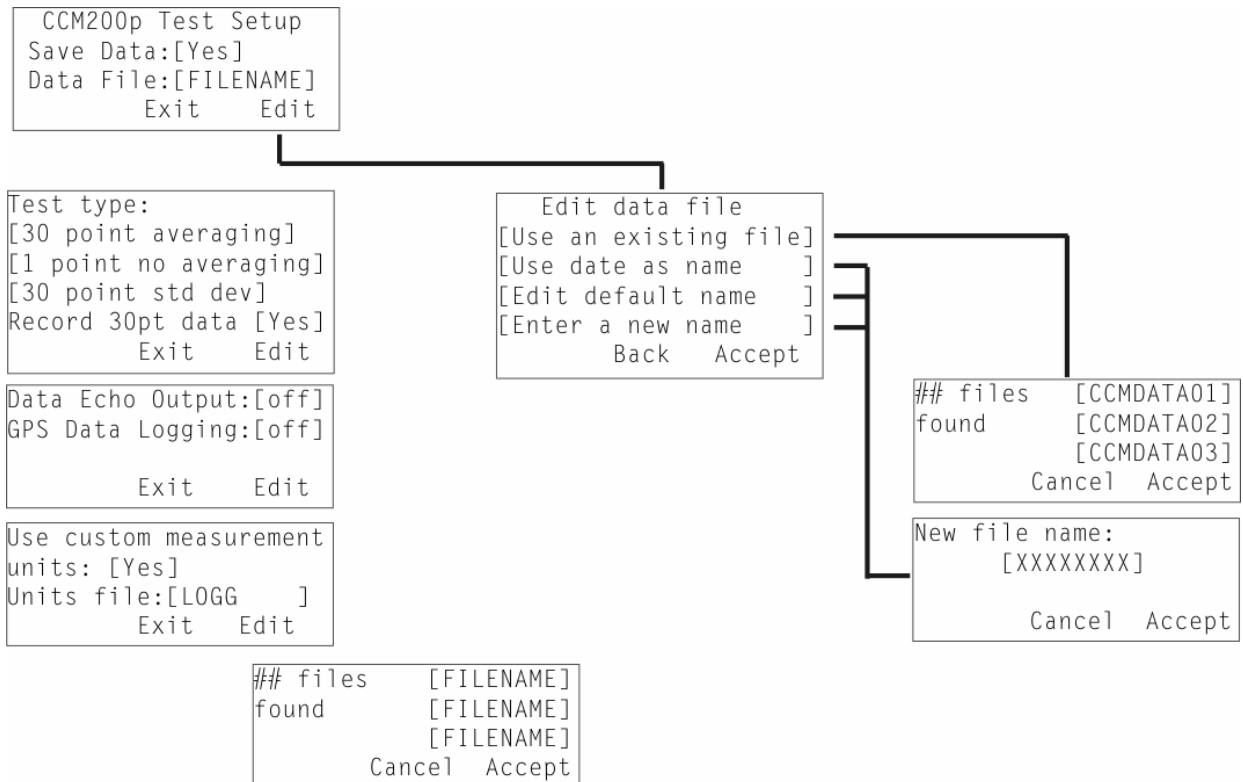

File name creation

To create a new file name, select edit from the "CCM200p Test Setup" screen. Use the right arrow to select the Data File. The File name manager screen will appear. "Use an existing file" will be highlighted. Use the up/down arrows to scroll through the options until "Enter a new name" is displayed. Press accept. The new file name screen will appear. Use the up/down arrows

to scroll through numbers 0-9, and A-Z. To move to the next or previous characters, use the right and left arrows. Press accept to save the entry. The newly created file name is now set to be used for measurements. Press exit to return to the Test Menu.

Note: A newly created file name will not appear on the list of existing measuring files until a measurement has been made.

Using an existing file name

To select an existing measuring file, select edit from the "CCM200p Test Setup" screen. Use the right arrow to select the Data File. The File name manager screen will appear. "Use an existing file" will be highlighted. Press Accept. Use the up/down arrows to scroll through the available file names, and press accept when the one you want is highlighted. The accepted file name is now set to be used for measurements. Press exit to return to the Test Menu.

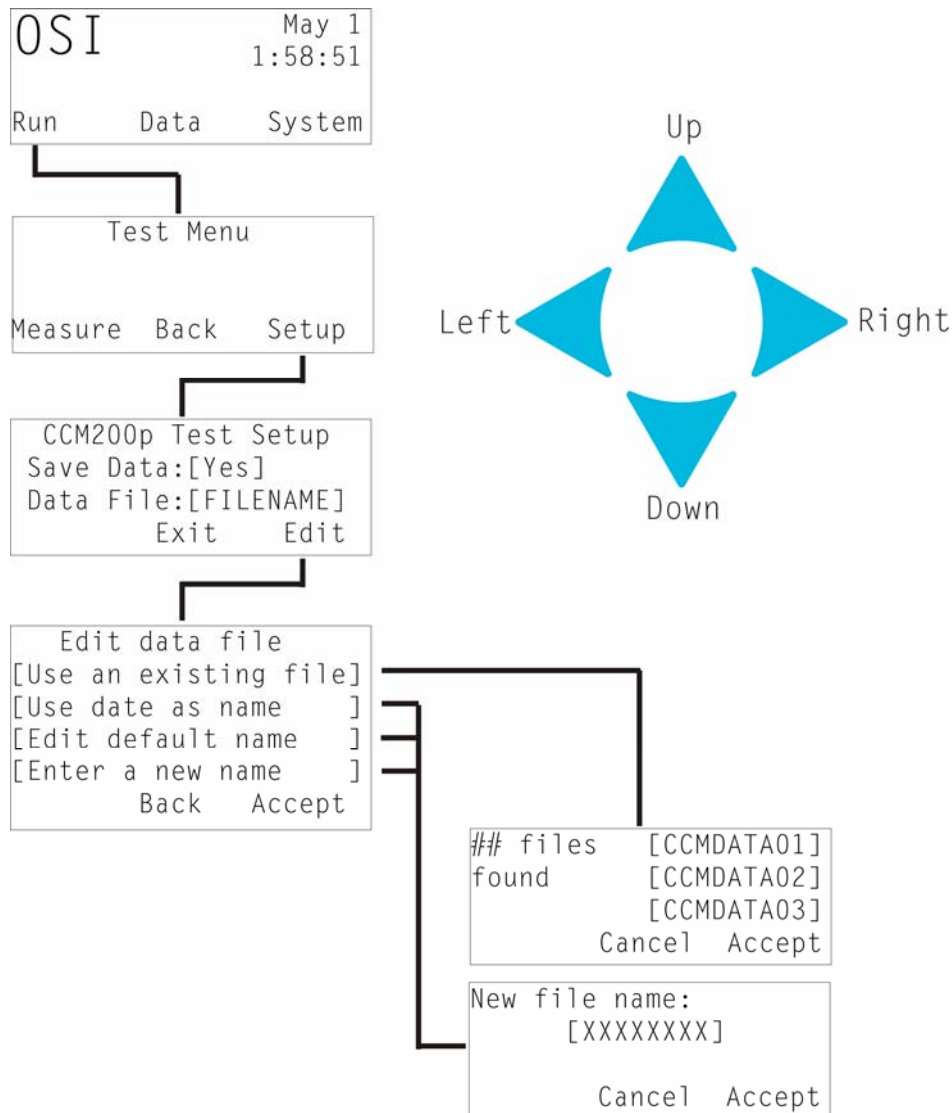

Calibration

Calibration is required every time the unit is turned on.

The unit's detection system needs to check its chamber path. The user has to calibrate or "zero" the instrument each time the unit is powered up.

To Calibrate the unit, close the measuring chamber.

Important: make sure chamber is clear of any material.

Hold the chamber closed until the release arm message is displayed on the screen.

Calibration is not required in-between measurements, only when the system is powered up. The unit is ready to take another measurement once the current measurement is displayed.

Test Types

There are three test types on a standard CCM-200 plus.

Single point measurement

This test saves every data point. Place the sample in the chamber, and press the head closed. A value will appear when the test is complete. The next measurement may then be taken.

Multi-Point averaging

Multi-point averaging is used for some nitrogen management schemes. One can choose to average from 2 to 30 measuring points Please refer to the following papers for more details.- (Shapero 2006) (Francis 1999) The papers listed here, use 30 point averaging and 10 point averaging respectively. Some crop consultants use fewer points to save time.

Multi-Point averaging with std. deviation flyer removal

This is the same test as listed above, but it will only allow averaging from 10 to 30 samples. If the difference between measurements is greater than 2 sigma, the instrument automatically throws out the measurement, and requires an additional measurement.

From the Test Menu and select setup.

Use the arrow keys to scroll through the various parameters available until the Test Type screen is displayed.

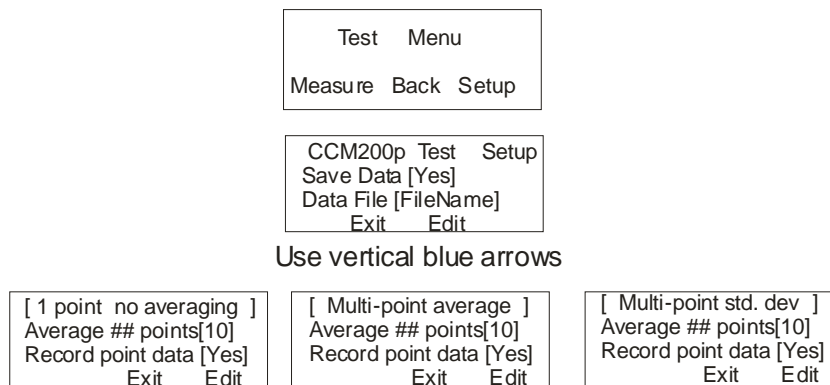

Press the edit green button, and use blue arrows

Select Edit, and use the arrow keys to scroll through the options until Multi-point average is highlighted. Press the horizontal blue arrow until the Average ## points is highlighted. Use the vertical arrows to select the number of points to be averaged. Press the Enter button to accept the selection.

Note: If the Multi-point std dev option is chosen then the system will only allow averaging of between 10 and 30 points.

Press Exit go back to the test menu.

Press measure to start taking measurements, or if needed, calibrate the unit.

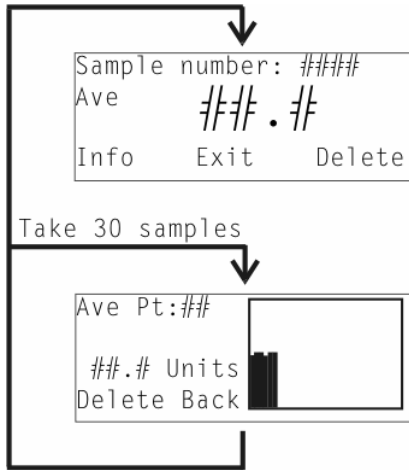

Place the sample under the measuring head and hold it closed until you hear a beep.

When using the one of the multi-point averaging modes, a measurement bar will appear on a graph for each measuring point. The number of measurements made, and last CCM measurement are also displayed.

When finished, the average of the Multi-point measurements is displayed. All measuring points are stored in the data file along with the calculated average.

The graphs may be reproduced in most spreadsheet programs if desired.

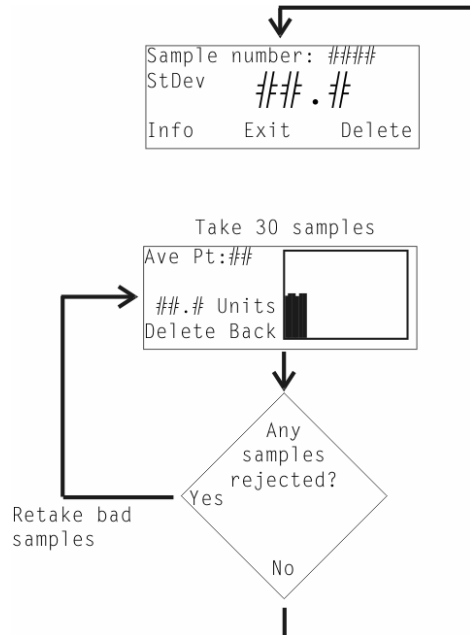

Enter Comments for measurements

If desired, a comment can be entered for each measurement. It may also be entered only when change is made, such as measuring location or sample type. The comment will only appear with the specific measurement. However, because there is a time stamp in the data file, all measurements below the comment line can be related to that comment.

To use the comment function follow the chart below. Alpha-Numeric characters may be entered using the vertical blue arrows below the screen. The horizontal arrows move the black cursor left and right. Comments of up to 20 characters may be entered. When done, press Enter. Back out to the measuring screen and continue measuring.

See the next page for a screen by screen diagram of how to enter comments.

Comments are entered by pressing Info on measuring screens.

Graphic display of Comment entry

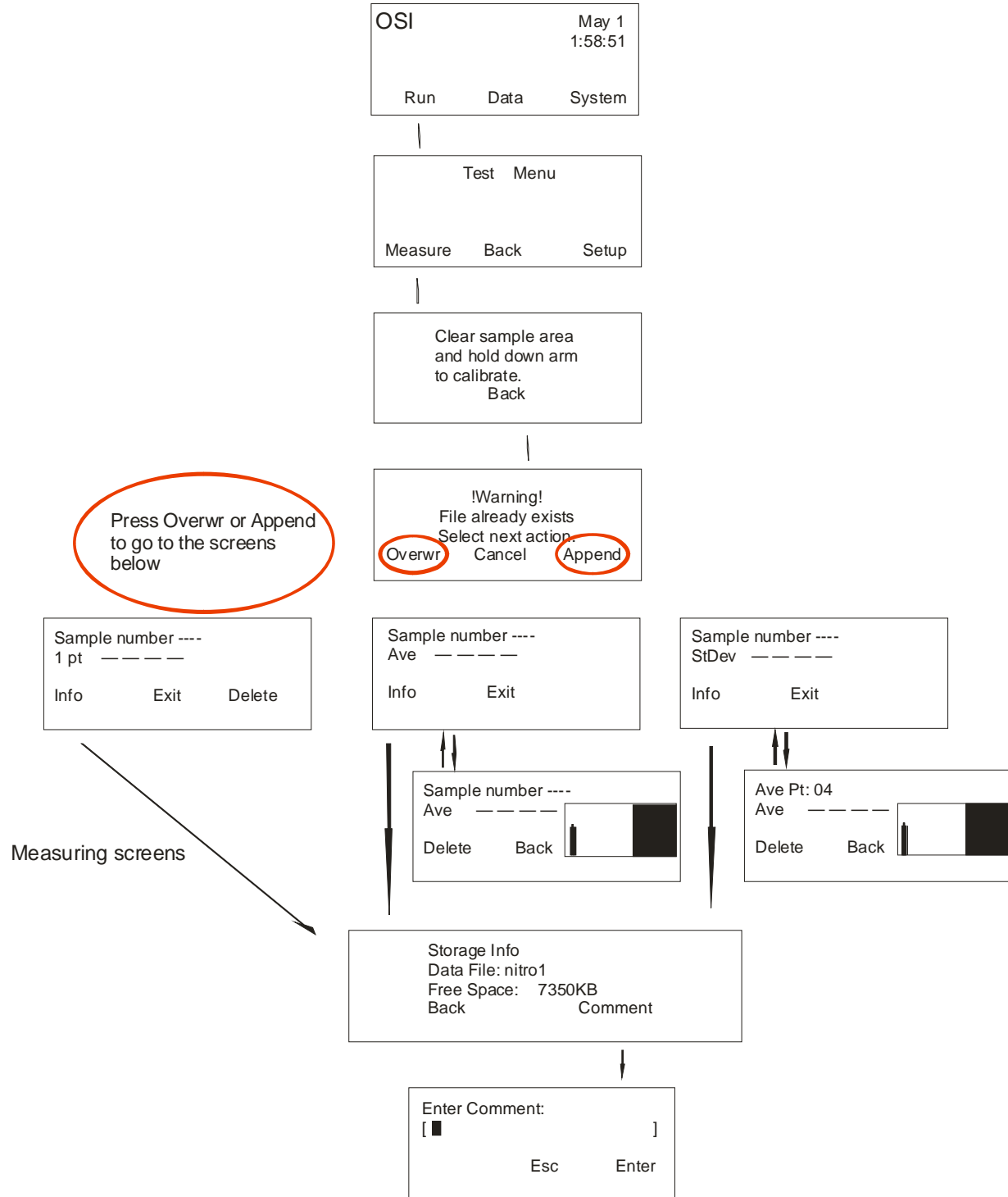

Data Management

Transfer data by USB

This is the recommended way to transfer files because it is the easiest way to do it.

Press cancel before unplugging the USB cable. Do not turn off the system until either the USB cable has been disconnected or the cancel button has been pressed. The message below will appear.

Make sure that under system set up, USB has been selected under Baud Rate. See system set up for more details.

Enter the data management screen by pressing the Data button

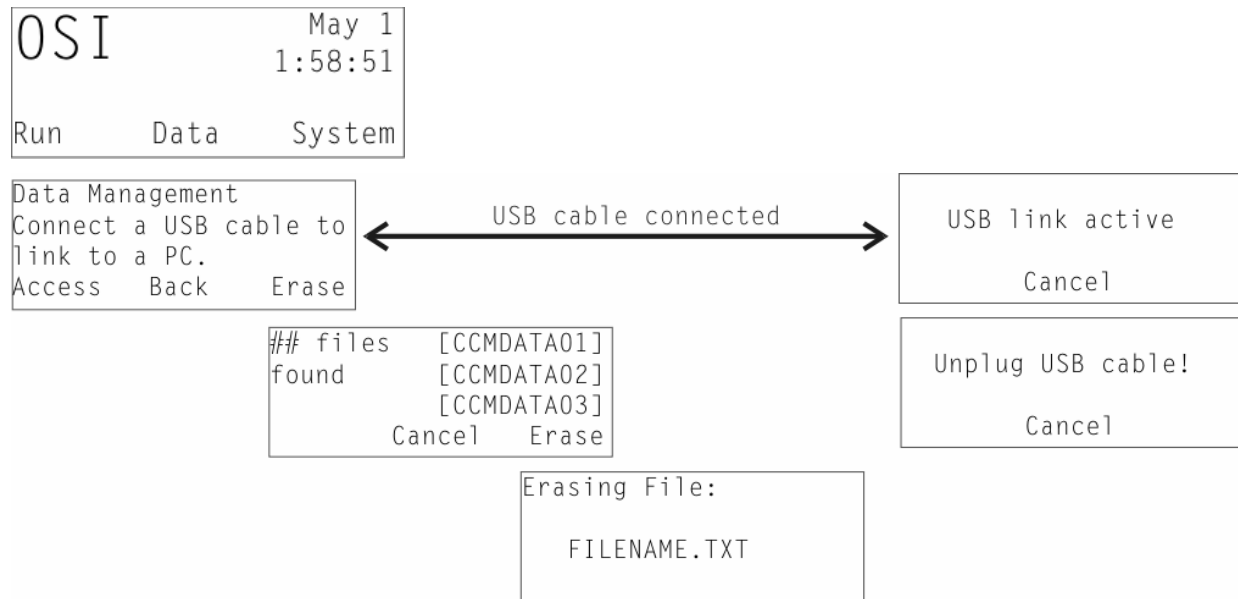

Connect a USB Cable between the unit and a PC

After connecting the USB cable, a storage device window will probably appear on your PC. The window asks you to select the correct viewing method. Select “Open window to view files using Windows Explorer”. If this window does not appear, then go to Windows Explorer and My Computer. Find the new drive that is usually listed as a letter and then CCM2p. When you see the files on the drive, right click the data files and copy them to the host PC. Then you can open the file with most spreadsheet or data processing programs.

Press cancel on the instrument before unplugging the USB cable.

Sending data by RS232.

USB is the recommended method of transferring files. Only use the RS232 port for data transfer if USB is unavailable.

The RS-232 jack is located at the bottom of the instrument. Only use the cable supplied by Opti-Sciences. A serial cable is not supplied, however it is available at no charge upon request.

Connect the RS232 cable to the CCM-200 plus and the host PC.

Enter the data management window by pressing the data button from the main menu.

```

OSI                May 1
                   1:58:51
Run      Data      System

```

Open a terminal emulation program, such as Hyperterminal (included with most installations of Windows).

Communication Settings

Data is sent in an ASCII text format with carriage returns separating each point. The default host settings are 9600 baud, 8 bit, 1 stop bit, no parity, and no handshaking. This mode is ignored if no data has been saved to memory yet.

Baud rates for the Serial port may be changed by going to the main test screen and pressing system. Next press Setup, and scroll down to Serial Port Baud rate with the arrow keys. Press Edit, and scroll through the values until the correct setting is found.

```

Serial port output
Baud rate [ 9600]

Exit      Edit

```

To initiate the data transfer, press Access and then Output

Select the file you want to send, and press Send. A status screen will display during the transfer.

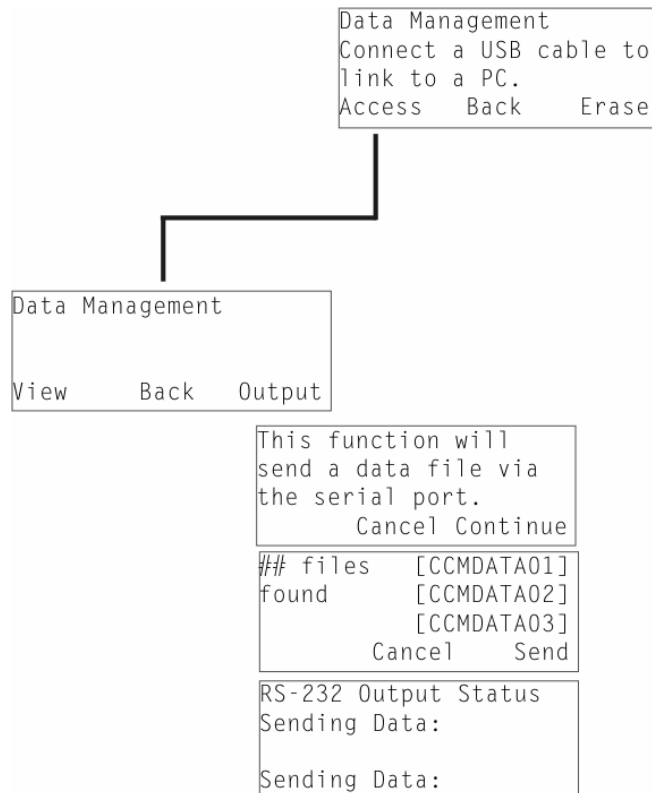

Technical Specifications

- Measured Parameters:** Optical Transmittance at 653nm., and at 931nm.
CCI = % Transmittance at 931nm. / % Transmittance at 653 nm.
- Measurement Area:** 3/8" diameter circle, or 9.53 mm diameter circle
area 0.11in² , or 71.22 sq mm²
- Repeatability:** +/- 5%
- Accuracy** Determined by correlation with chemical analysis
- Sample Acquisition Time:** 2-3 Seconds
- Source:** 2 LEDs
- Detector:** Silicon photodiodes with integral amplifier for absorbance measurement and source power monitoring for temperature compensation
- Storage Capacity:** More than 100,000 data points
- User Interface:** 50mm X 15mm graphic display screen, 8 keys for control and data manipulation, audible alert for status and warnings
- Input and Output:** A mini USB port is provided as the main data transfer port.
An RS-232 port can also be used for data transfer
The RS232 port is also used with a compatible GPS receiver for integrated measurement and location data.
- Operating temperature range:** 0-50° C.
- Temperature drift:** Temperature compensated source and detector circuitry for minimum drift over full range.
- Battery:** 9V alkaline cell
- Auto-off interval:** 4 minutes (with no key press or download)
- Weight:** 168g (not including battery)
- Dimensions:** 152(L)x82(W)x25(D)mm
- GPS option:** The single pin RS232 port is used for GPS. Location data is saved with measuring data for each measurement in the measuring file.

ERROR CODES

The error codes describe the problem encountered.

Error Codes miscellaneous message text info for version 1.3a 5/11 rr

Boot up message: errors with uSD memory:

"SD init error"

"Continue"

"SD error #xx"

"on command #xx"

"NV load error"

"Continue"

Fix:

If you get any of the 3 errors above, first take out the battery, hold the power switch for 30 sec, then replace battery. If error goes away ok, else the unit will probably need to come in for service.

" ! Error Warning !"

"File System Corrupt!"

"Perform Format on Unit"

"Continue"

Fix:

This error occurs if the uSD card is corrupted. We saw this when the power was switched off while still in transfer mode. It may also be caused by disconnecting the unit before stopping communications with the PC. The power off event was fixed in software version version 1.05. If you have an earlier version of software the following process may be used to reset the instrument:

Reconnect the CCM to the PC. Go to My Computer, find the CCM200 drive, and right click the drive. Left click Format, and then left click Start. This will reformat the drive. All data that was on the instrument will be lost. With earlier versions of software, it is important to either push the cancel button or disconnect the USB cable before turning off the instrument.

Message during app upgrade:

" CCM200p LOADER "

" Updating Application "

" Please Wait!"

This message is displayed during an application upgrade.

" ! nvRAM Init !"

This message will sometimes follow a software update. It may also appear after the unit is formatted by the PC. It indicates that the system defaults are being restored. It should not appear every time the unit is turned on. That would indicate a uSD card fault.

Test errors:

"Custom file not found!"

"CCI units will be used"

Fix:

This message will appear if the "Use custom measurementunits [Yes]" setting is selected. It means that the lookup table for this feature is not present. Simply turn feature off to clear the message.

"Warning! Average must "
"be \geq 10 pts for std dev"
"mode. A setting of 10 "
"points will be used."

Fix:

This message will appear for the standard deviation test mode when the number of samples is less than 10 points. It must be 10 or greater.

" !! Warning !!"
" Drive is Full"

Fix:

This will appear if the devices memory is full. Delete some unused data to remedy this problem.

"Sample too dense"

Fix:

This message warns that the amount of signal absorbed by the sample is too great for reliable measurements. Try locating to a different part of the sample.

" Hold arm down "
" for whole test!"

Fix:

This message appears if the sample chamber is not closed for the duration of the test.

"Light Leak!"

Fix:

This message indicates that there is too much light present during the test zero phase. This may be due to worn gaskets or non-flat samples. Return to Dealer for repair.

Calibration errors:

"Clean Sample Chamber!"

Fix:

This message occurs during a calibration if the amount of light through the chamber is below a certain level. This may be due to dirt on the diffusers or debris in the sample area. It may also be caused by a mechanical or electrical problem. Clean chamber and re-try first then contact service.

"Source/Detector Fail!"

Fix:

This message indicates that the unit has detected a fault with one of its sensing components. It should be referred back to the factory of inspection.

"Chamber Light Leak!"

Fix:

This will occur with worn gaskets or possibly a defective detector. Contact service for new gaskets or other instructions.

Data view & output errors:

"File is Corrupt!"

Fix:

This error may occur due to a file being corrupted by an aborted transfer to the PC or by removing the unit's battery instead of using the power switch to turn the unit off.

Technical Support

Opti-Sciences provides technical support for all products, either directly to end users or through our distributors. Please contact your local representative, or contact Opti-Sciences directly for questions including technical assistance, instrument maintenance and repair. Warranty service period is determined by instrument serial number. Please have the serial number available when making service inquiries.

In North America, contact:

Opti-Sciences, Inc.
8 Winn Avenue
Hudson, NH 03051
USA

Tel: (603)883-4400

Fax: (603)883-4410

Internet: www.optisci.com

e-mail: support@optisci.com

References:

- Knighton N. Bugbee B. A comparison of Opti-Sciences CCM-200 Chlorophyll Meter and the Minolta SPAD 502 Chlorophyll Meter Crop Physiology Dept, Utah State University
- CATE T. M. , and PERKINS T. D. (2003) Chlorophyll content monitoring in sugar maple (*Acer saccharum*) Tree Physiology 23, 1077–1079© 2003 Heron Publishing—Victoria, Canada
- de Carvalho J. F.Gonçalves (2008) 1,3, Ulysses Moreira dos Santos Junior¹ e Emerson Alves da Silva² Evaluation of a portable chlorophyll meter to estimate chlorophyll concentrations in leaves of tropical wood species from Amazonian forest (2008) Hoehnea 35(2): 185-188, 1 tab., 1 fig., 2008
- ELLISON A. M. AND FARNSWORTH E. J., (2005) THE COST OF CARNIVORY FOR DARLINGTONIA CALIFORNICA (SARRACENIACEAE): EVIDENCE FROM RELATIONSHIPS AMONG LEAF TRAITS¹ American Journal of Botany 92(7): 1085–1093. 2005.
- Fracheboud Y., Luquez V. , Björkén L. , Sjödin A. ,Tuominen H., and Jansson S. The Control of Autumn Senescence in European Aspen Plant Physiology 149:1982-1991 (2009)© 2009 American Society of Plant Biologists
- Francis D.D. and Piekielek W.P. Assessing Crop Nitrogen Needs with Chlorophyll Meters, (1999) Site-Specific Management Guidelines series is published by the Potash & Phosphate Institute (PPI) Coordinated by South Dakota State University (SDSU) Coordinated by South Dakota State University (SDSU) # SSMG-12
- Gielen B.,* , Loew M., Deckmyn G., Metzger U., Franck F. , Heerdt C. , Matyssek R. , Valcke R. and Ceulemans R., (2007) Chronic ozone exposure affects leaf senescence of adult beech trees: a chlorophyll fluorescence approach Journal of Experimental Botany, Vol. 58, No. 4, pp. 785–795, 2007
- Jamil M. and Rha E.S., Effect of Different Water Table Treatments on Cabbage in Saline Saemangeum Soil, Salinity and Water Stress Volume 44
- Jamil M. J.; Rehman S.; Lee K J.; J Kim J.M.; Kim H. S.; Rha¹ E. S., (2007) SALINITY REDUCED GROWTH PS2 PHOTOCHEMISTRY AND CHLOROPHYLL CONTENT IN RADISH Sci. Agric. (Piracicaba, Braz.), v.64, n.2, p.111-118, March/April 2007
- KARDEL F., WUYTS K., and SAMSON R. (2010) Foliage responses of urban plants to urban habitat quality in the city of Gent, Belgium CLIMAQS Workshop ‘Local Air Quality and its Interactions with Vegetation’ January 21-22, 2010, Antwerp, Belgium
- Knighton N. Bugbee B. A comparison of Opti-Sciences CCM-200 Chlorophyll Meter and the Minolta SPAD 502 Chlorophyll Meter
- Liberloo M. , Tulva I., Raïm O., Kull O. and Ceulemans R. (2007) Photosynthetic stimulation under long-term CO₂ enrichment and fertilization is sustained across a closed Populus Blackwell Publishing Ltd New Phytologist (2007) 173 537–549
- Martin, L.T. Pezeshki, S.R. Shields, F.D. Jr. (2004) USDA, ARS High Oxygen Level in a Soaking Treatment Improves Early Root and Shoot Development of Black Willow Cuttings. Scientific world. 2004 Oct., v. 4, p. 899-907.

Morris J (2008) *Macrotyloma axillare* and *M. uniflorum* : descriptor analysis, anthocyanin indexes, and potential uses Genetic Resources and Crop Evolution

Volume 55, Number 1 / February, 2008 Pg 5-8

Morris J., Wang M., Patrick D. Biber P. D.,(2007) Evaluating a Chlorophyll Content Meter on Three Coastal Wetland Plant Species. *Journal of Agricultural Sciences* Volume 1, Issue 2, 2007 Issue 1934-7235

Pagter M., Liu F., Jensen C.R. K.K. Petersen (2008) Effects of chilling temperatures and short photoperiod on PSII function, sugar concentrations and xylem sap ABA concentrations in two *Hydrangea* species *Plant Science* Volume 175 Issue 4 Oct 2008 pages 547-555

Rodrigo M. C., López D., Carazo N. , Ramos C. (2001) NITRATE SAP AND CHLOROPHYLL METERS AS NITROGEN MONITORING TOOLS FOR ARTICHOKE GROWN IN SAND CULTURE *ISHS Acta Horticulturae* 747

Shapiro C.A. , Schepers J.S., Francis D.D. Shanahan J.F. Using a Chlorophyll Meter to Improve N Management (2006) *NebGuide*, University of Nebraska- Lincoln Extension, Institute of Agricultural Resources #G1632. Index: Soil Resource Management Fertility, issued October 2006.

Sjödin A. , Wissell K., Bylesjö M., Trygg J., Jansson S. (2008) 1 Global expression profiling in leaves of free-growing aspen *BMC Plant Biology* 2008, 8:61 doi:10.1186/1471-2229-8-61

Urso G. D , Dini L., Vuolo F., Alonso L., Guanter L. (2003) RETRIEVAL OF LEAF AREA INDEX BY INVERTING HYPER-SPECTRAL, MULTI-ANGULAR CHRIS/PROBA DATA FROM SPARC 2003 Proc. of the 2nd CHRIS/Proba Workshop, ESA/ESRIN, Frascati, Italy 28-30 April (ESA SP-578, July 2004)

Van den Berg A. K., Perkins D. (2005) Non destructive Estimation of Anthocyanin Content in Autumn Sugar Maple Leaves *HortScience* 40(3):685-686 2005

Van den Berg A. K., Perkins D. (2004) Evaluation of a portable chlorophyll meter to estimate chlorophyll and nitrogen contents in sugar maple (*Acer saccharum* Marsh.) leaves, *Forest Ecology and Management* 200 (2004) 113–117

WANG A.,ZHANG C. ,WU C. ,GAO M. (2008) Study on a Fast Method of Testing Chlorophyll Content in Maize *Journal of Maize Sciences* 2008-02

Yongxiu L., Maarten K, and Wim J. Soppe J. (2007), The Absence of Histone H2B Monoubiquitination in the *Arabidopsis* *hub1* (*rdo4*) Mutant Reveals a Role for

Chromatin Remodeling in Seed Dormancy *The Plant Cell*, Vol. 19: 433–444, February 2007, www.plantcell.org a 2007 American Society of Plant Biologists

ZAEFYZADEHI M., QULIYEV R. A. , BABAYEV S.M., ABBASOV M. A. (2009)

The Effect of the Interaction between Genotypes and Drought Stress on the Superoxide Dismutase and Chlorophyll Content in Durum Wheat Landraces *Turk J Biol* 33 (2009)

1-7 © TÜBİTAK

References and further reading may be available for this article. To view references and further reading you must purchase this article.